

NO	SYMBOL	DESCRIPTION
1		5 A PLUG POINT
2		15 A POWER POINT
3		15 A STABILISED OUTLET
4		TELEPHONE SOCKET OUTLET
5		COMPUTER SOCKET OUTLET
6		5 A STABILISED OUTLET

JOB TITAL-
 PROPOSED INTERIOR WORK OF
 BANK OF MAHARASHTRA
 BRANCH - LIMB , DIST-SATARA
 CLIENT - BANK OF MAHARASHTRA

PROPOSED LAYOUT
 UPS LAYOUT
 13-02-2021

E:\bank of maharashtra\ALIMB\LOGO .jpg

01

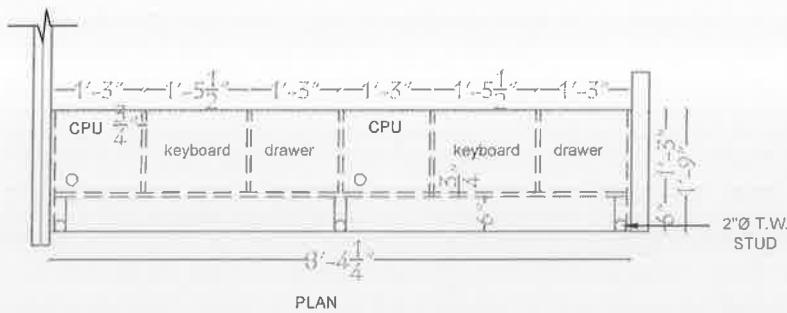
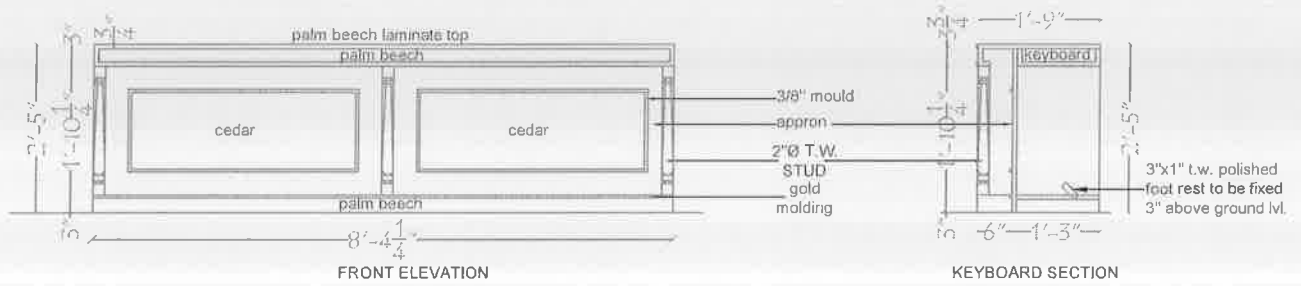
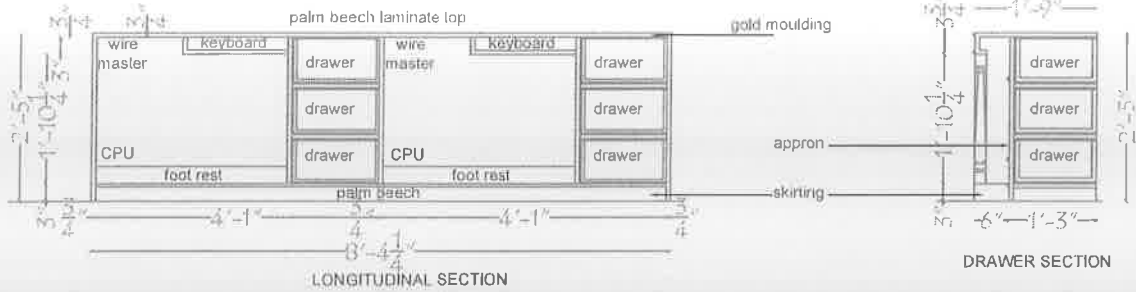

JOB TITAL-
PROPOSED INTERIOR WORK OF
BANK OF MAHARASHTRA
BRANCH - LIMB , DIST-SATARA

CLIENT - BANK OF MAHARASHTRA

CLERK TABLE UNIT
DRAWING NO: 01
03-12-2020



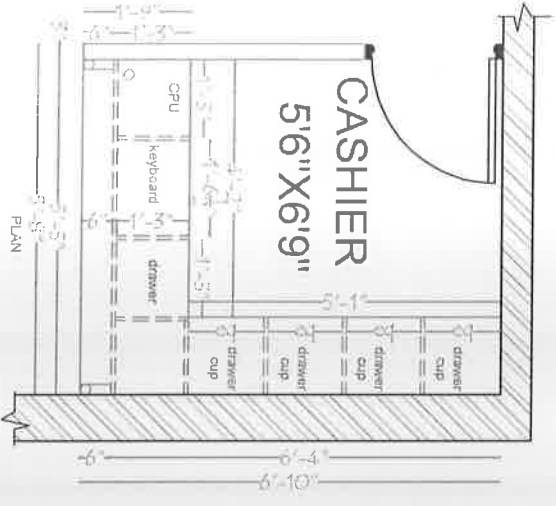
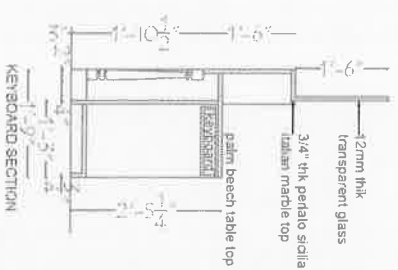
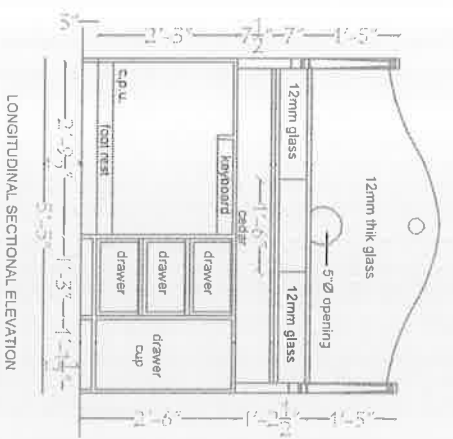
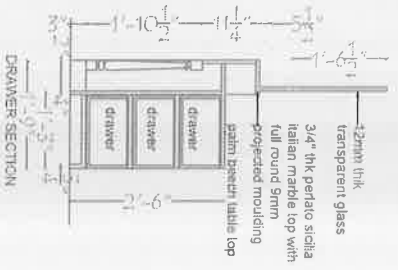
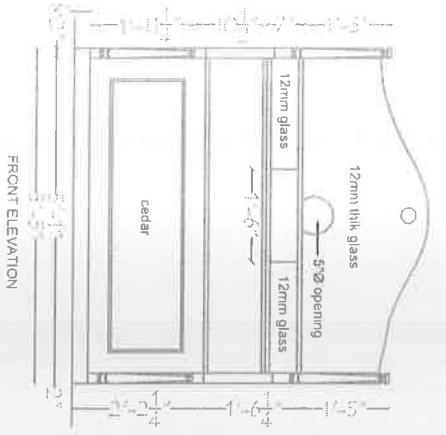

CASHIER
5'6" X 6'9"

JOB TITIAL -
PROPOSED INTERIOR WORK OF
BANK OF MAHARASHTRA
BRANCH - LIMB. DIST-SATARA
CLIENT - BANK OF MAHARASHTRA

CASH COUNTER DETAILS
DRAWING NO: 02
30-11-2020



STUDIO
GENESIS
ARCHITECTURE INTERIOR DESIGN

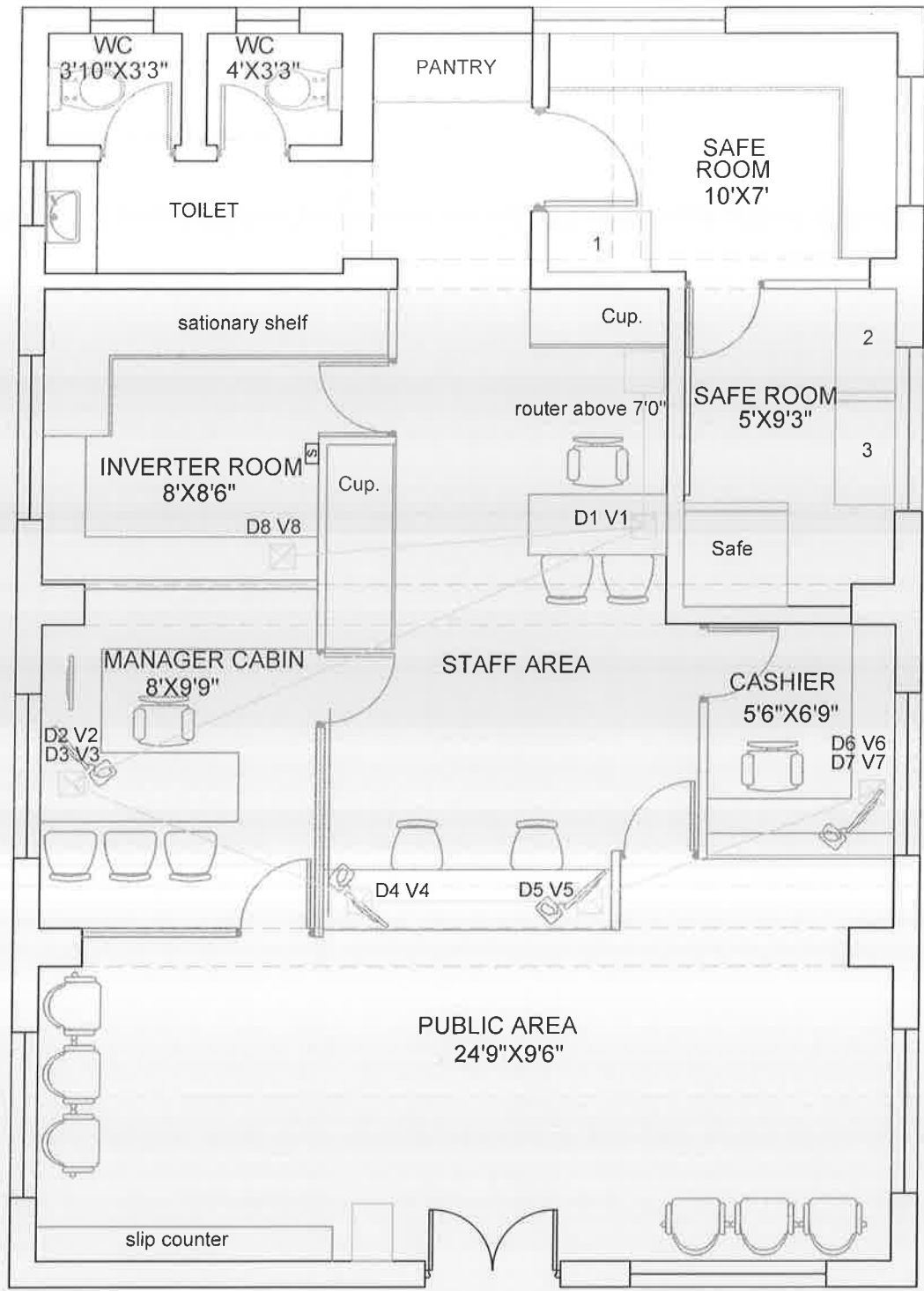

NO	SYMBOL	DESCRIPTION	QTY
1	☒	points on table	16
2	—	TRUNKING at slab lvl Floor for Data & Voice	

NO	SYMBOL	DESCRIPTION	QTY
3	D	DATA POINT	16
4	V	VOICE POINT	17

JOB TITAL-
 PROPOSED INTERIOR WORK OF
 BANK OF MAHARASHTRA
 BRANCH - LIMB , DIST-SATARA
 CLIENT - BANK OF MAHARASHTRA

PROPOSED LAYOUT
 DATA LAYOUT
 13-02-2021



E:\bank of maharashtra\LIMB\LOGO .jpg

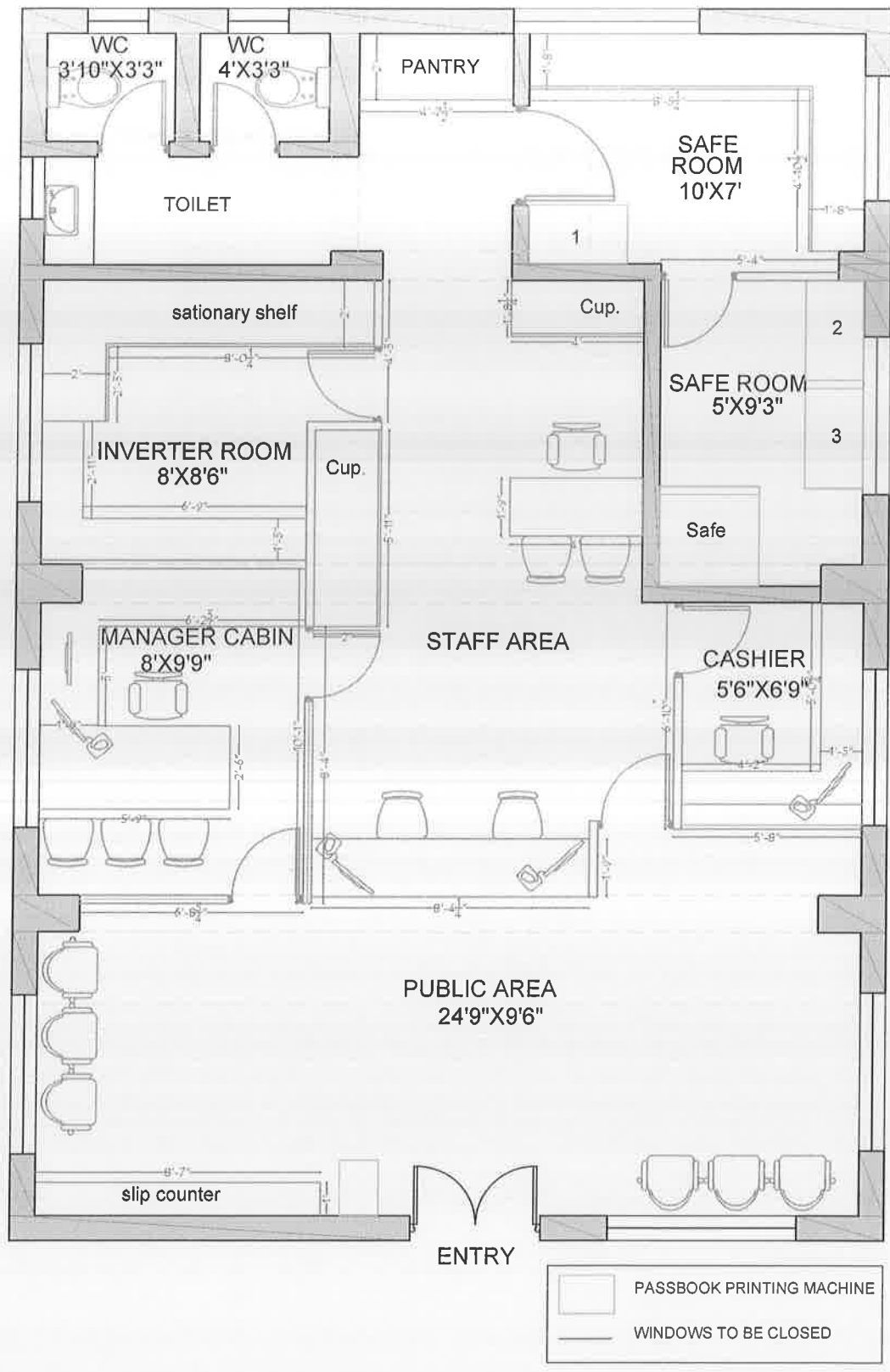

JOB TITAL-
 PROPOSED INTERIOR WORK OF
 BANK OF MAHARASHTRA
 BRANCH - LIMB , DIST-SATARA
 CLIENT - BANK OF MAHARASHTRA

PRAPOSED FURNITURE LAYOUT
 13-02-2021

E:\bank of maharashtra\LIMB\LOGO.jpg

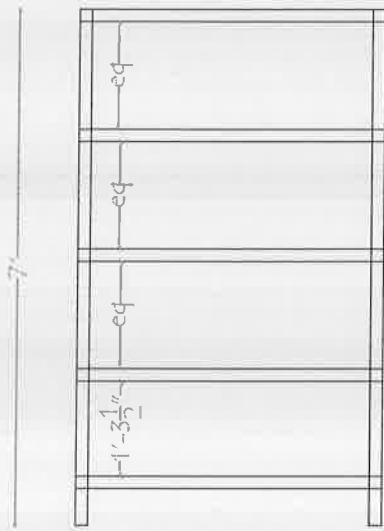

ELEVATION

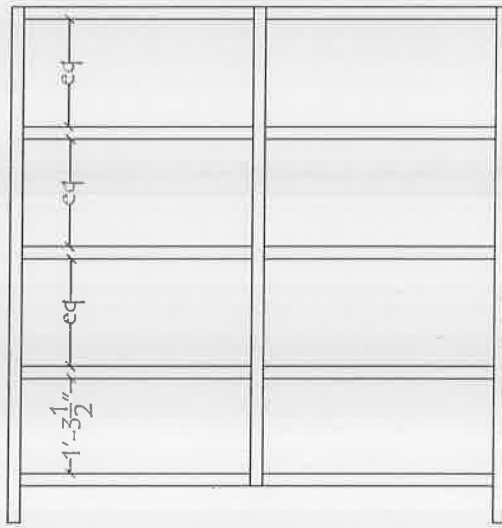

ELEVATION

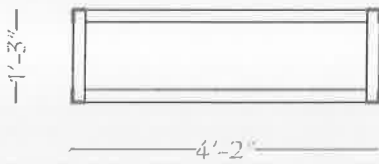

PLAN

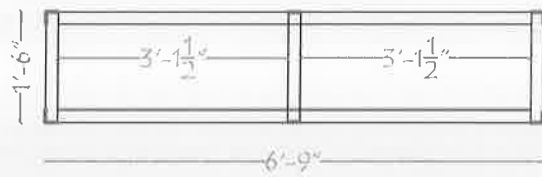

PLAN

JOB TITAL-
PROPOSED INTERIOR WORK OF
BANK OF MAHARASHTRA
BRANCH - LIMB , DIST-SATARA

CLIENT - BANK OF MAHARASHTRA

INVERTER ROOM RACKS

DRAWING NO: 06

03-12-2020



STUDIO
GENESIS
ARCHITECTURE | INTERIOR | LANDSCAPE

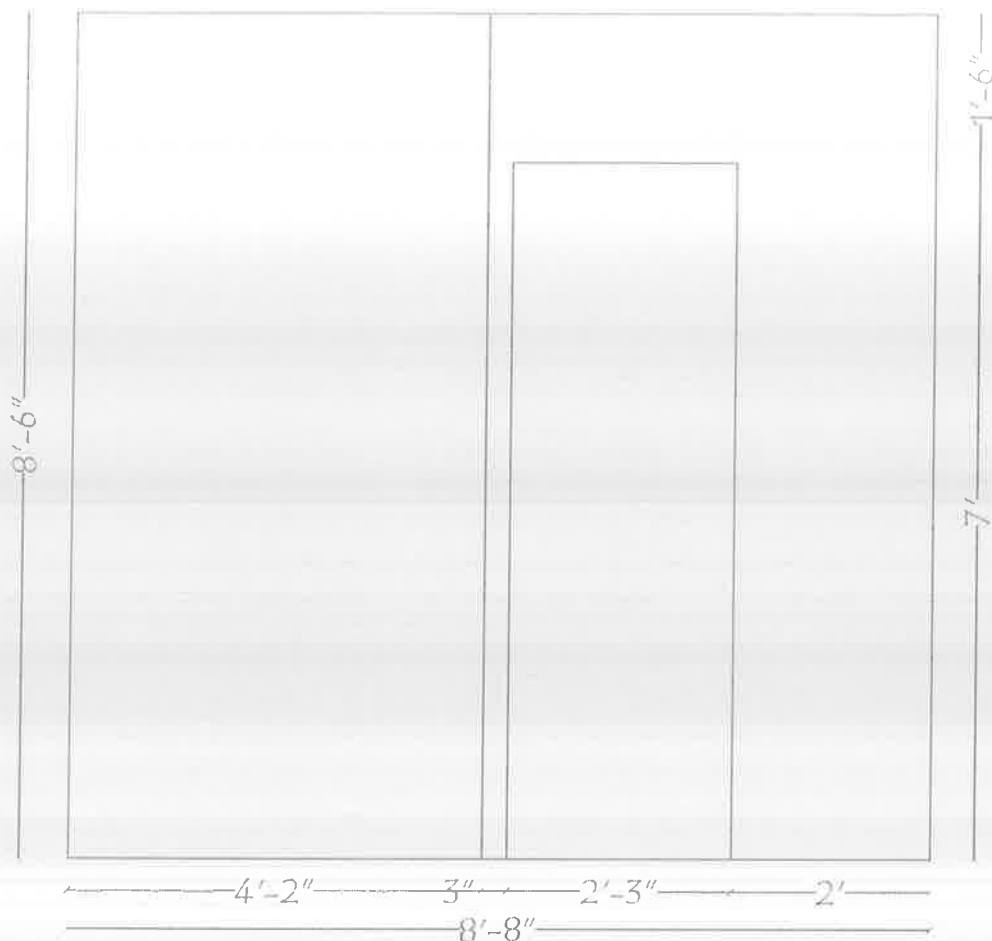

ELEVATION

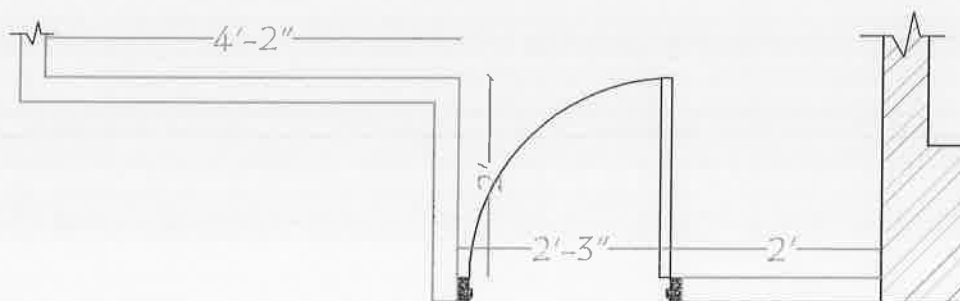

PLAN

JOB TITAL-
 PROPOSED INTERIOR WORK OF
 BANK OF MAHARASHTRA
 BRANCH - LIMB, DIST-SATARA

CLIENT - BANK OF MAHARASHTRA

SOLID PARTITION FOR INVERTOR ROOM

DRAWING NO: 05

03-12-2020



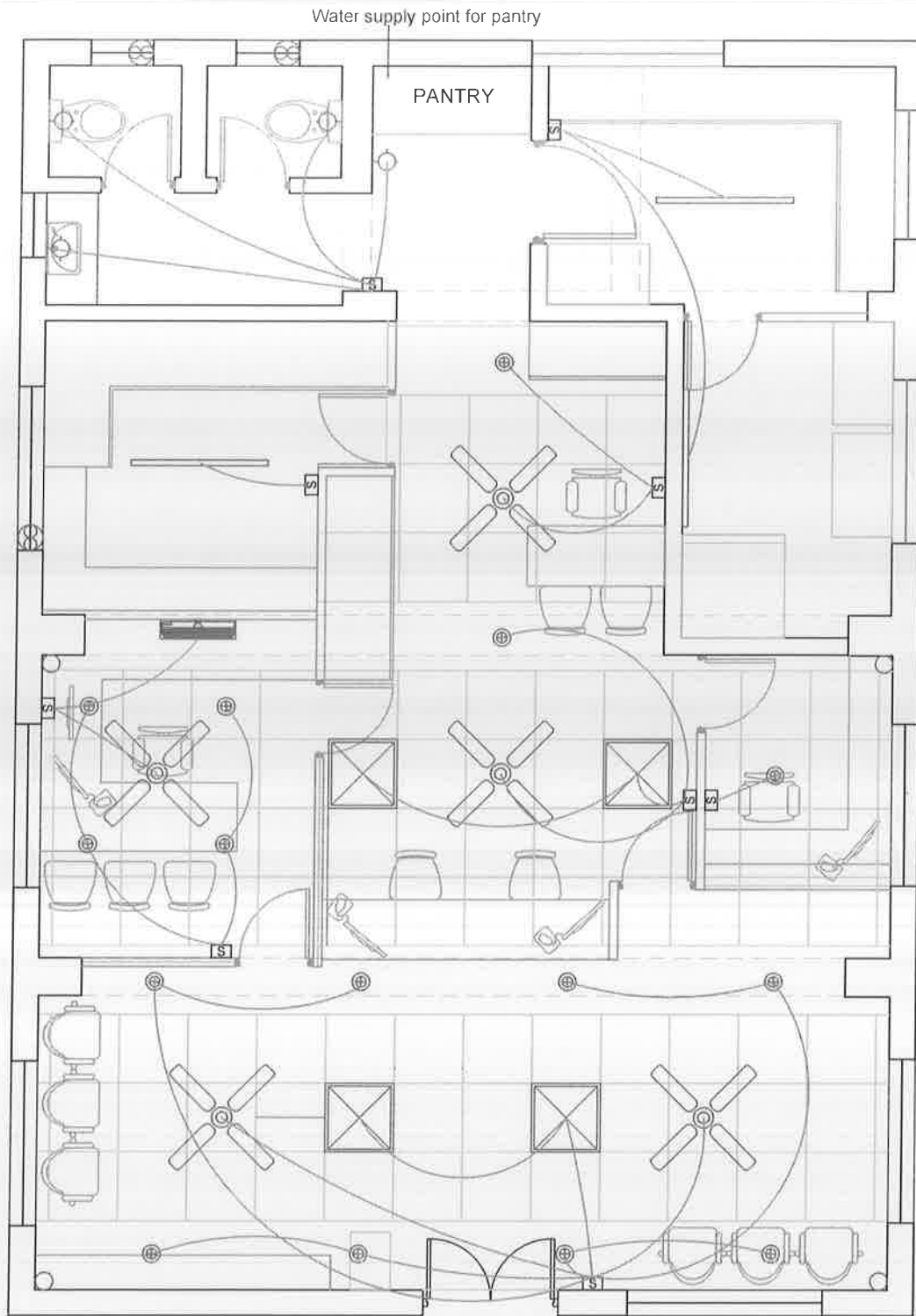

- ceiling line
- 600 x 600 Armstrong ceiling panel
- - - Beam line
- main supply line
- ⊗ 600 x 600 LED fitting - 4nos
- ⊙ LED fitting circular- 15 nos.
- 4' Tube- 7nos.
- Ⓢ switch board
- ⊗ ceiling fan- 5nos.
- AC - 1nos.
- ⊙ CCTV - 4nos.
- ⊗ Exhaust - 3nos.

JOB TITAL-
 PROPOSED INTERIOR WORK OF
 BANK OF MAHARASHTRA
 BRANCH - LIMB , DIST-SATARA
 CLIENT - BANK OF MAHARASHTRA

PROPOSED FALSE CEILING,
 LIGHT FITTINGS & AC LAYOUT
 13-02-2021

E:\bank of maharashtra\LIMB\LOGO.jpg

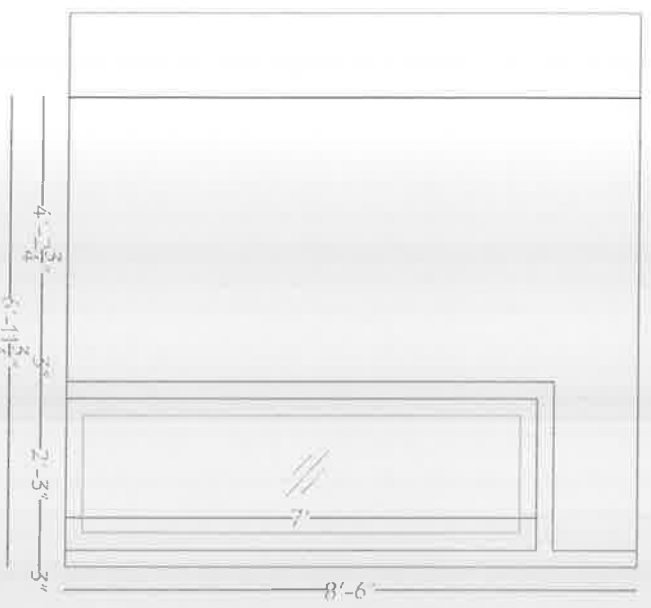

FRONT PARTITION

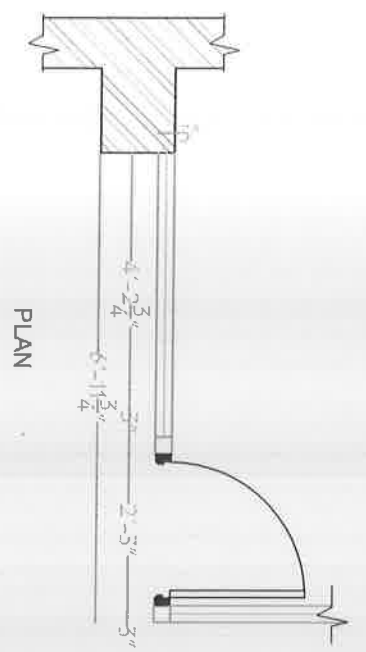

PLAN

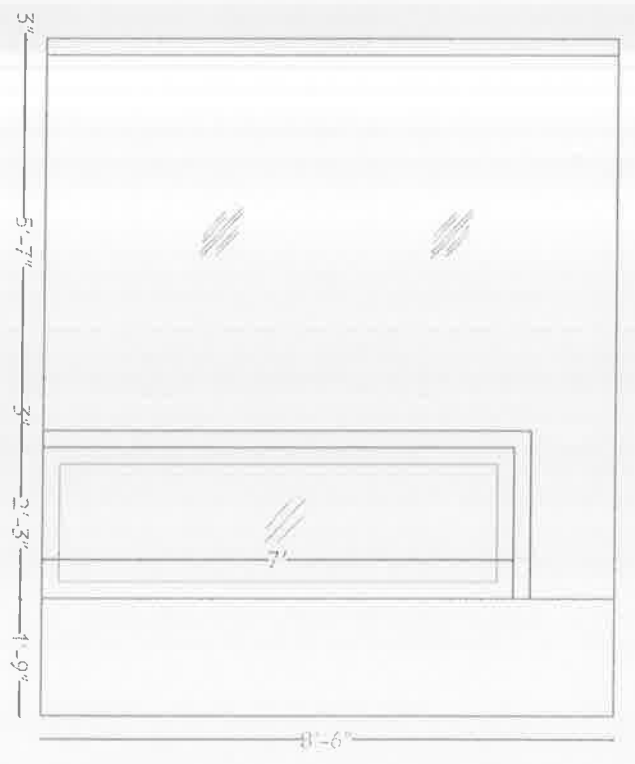

SIDE PARTITION

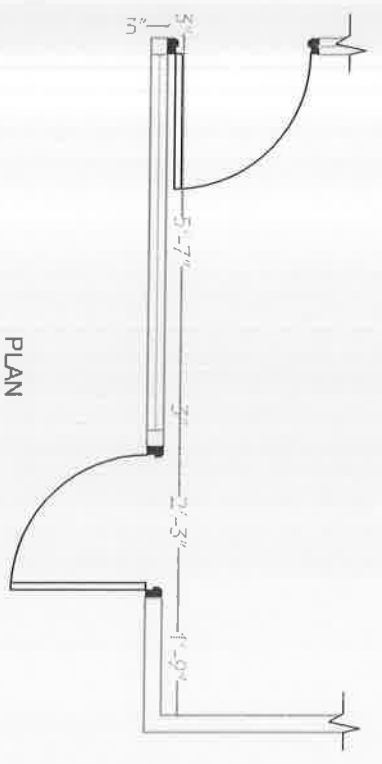

PLAN

JOB TITLE -
PROPOSED INTERIOR WORK OF
BANK OF MAHARASHTRA
BRANCH - LIMB DIST-SATARA
CLIENT - BANK OF MAHARASHTRA

SEMI GLAZED & FULL PARTITION WITH DOOR - BRANCH MANAGER CABIN
DRAWING NO: 04
03-12-2020



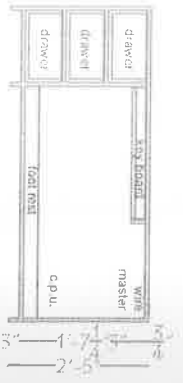

LONGITUDINAL SECTION

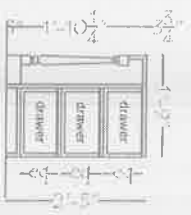

DRAWER SECTION



FRONT ELEVATION

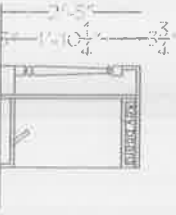

KEY BOARD SECTION

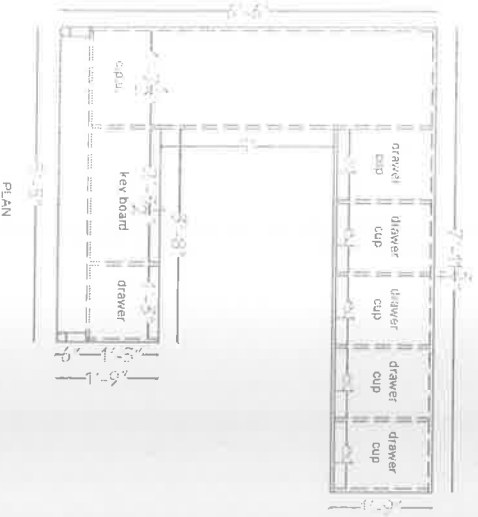

PLAN

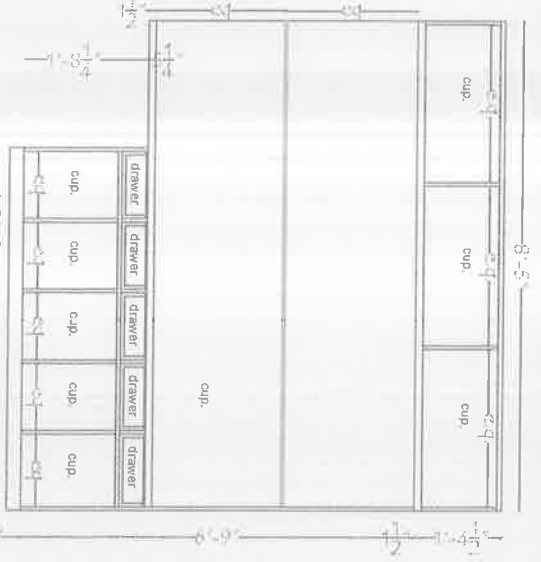

LONGITUDINAL SECTION

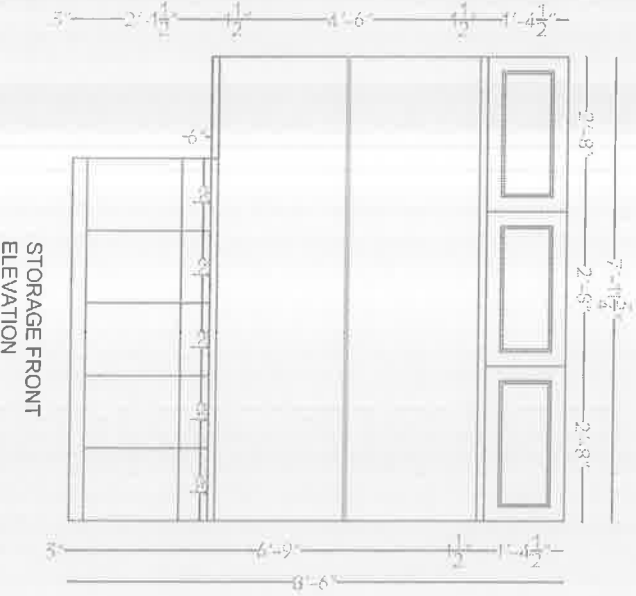

STORAGE FRONT ELEVATION

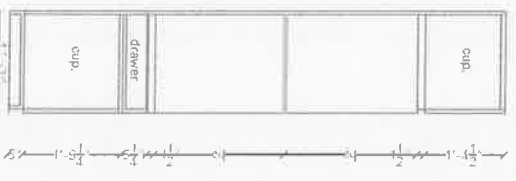

DRAWER SECTION

JOB TITLE -
 PROPOSED INTERIOR WORK OF
 BANK OF MAHARASHTRA
 BRANCH - LMB, DIST-SATARA
 CLIENT - BANK OF MAHARASHTRA

MANAGER TABLE WITH STORAGE UNIT
 DRAWING NO: 03
 03-12-2020

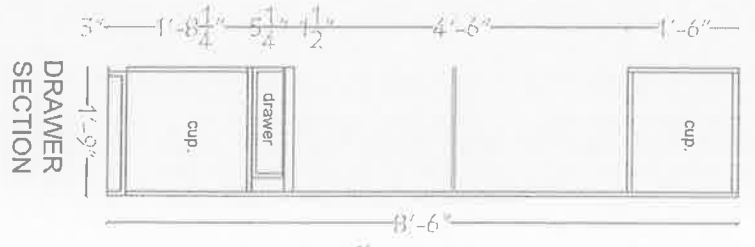
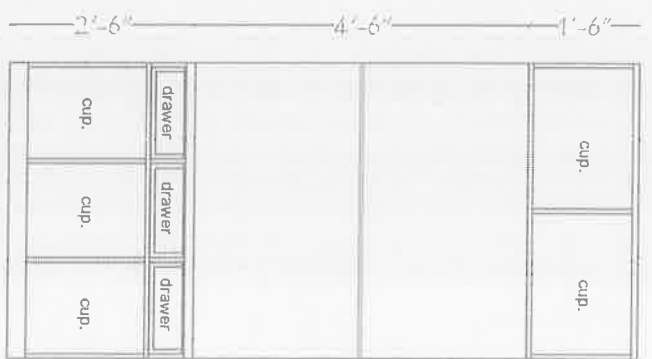
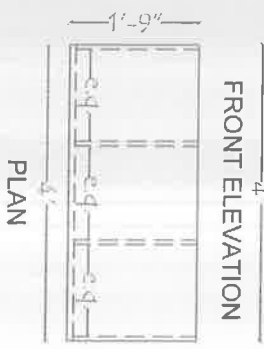
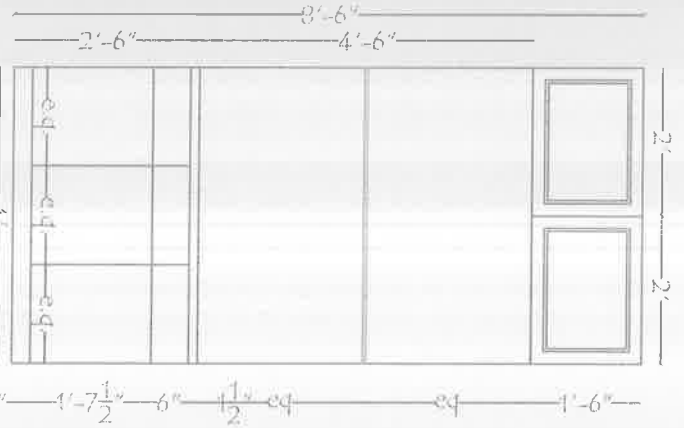
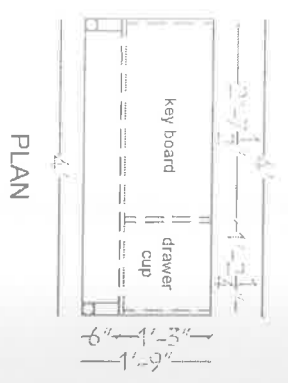
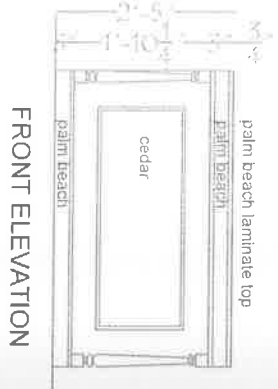
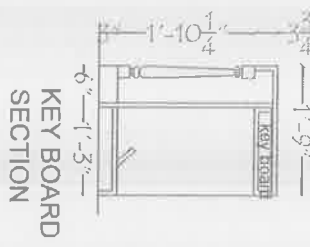
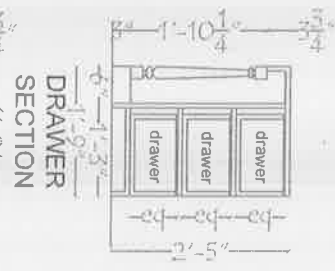
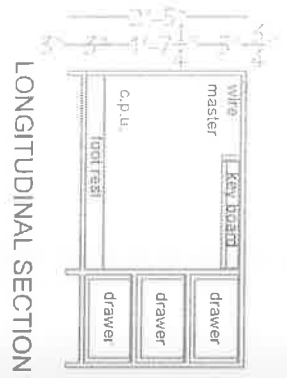

JOB TITLE:
 PROPOSED INTERIOR WORK OF
 BANK OF MAHARASHTRA
 BRANCH - LIMB. DIST-SATARA
 CLIENT - BANK OF MAHARASHTRA

OFFICER COUNTER WITH SIDE UNITS
 DRAWING NO: 07
 04-12-2020



STUDIO
GENESIS
 ARCHITECTURE | INTERIOR | LANDSCAPE

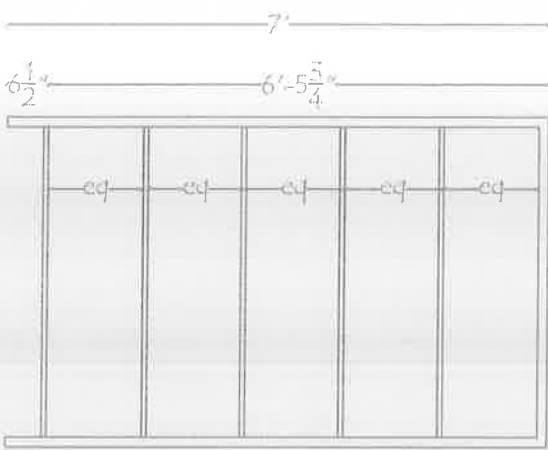

FRONT ELEVATION

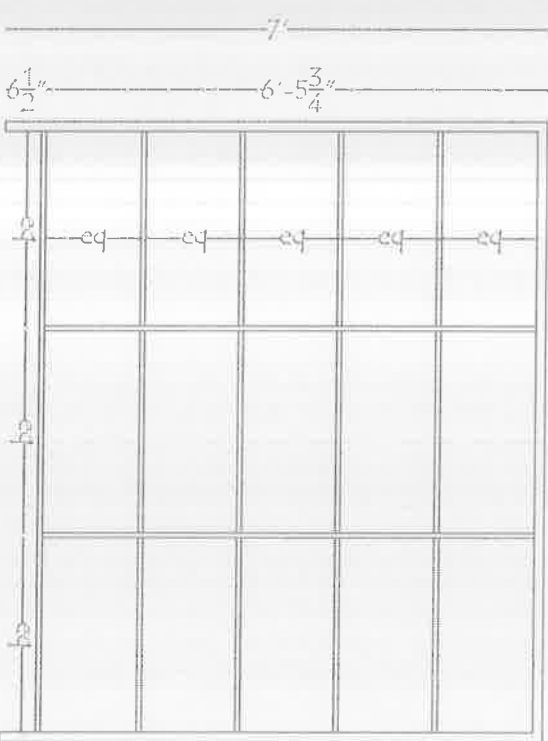

FRONT ELEVATION



PLAN



PLAN

JOB TITAL -
PROPOSED INTERIOR WORK OF
BANK OF MAHARASHTRA
BRANCH - LIMB , DIST-SATARA
CLIENT - BANK OF MAHARASHTRA

STATIONARY SHELF
DRAWING NO: 10
04-12-2020



STUDIO
GENESIS
ARCHITECTURE | INTERIOR | LANDSCAPE

09

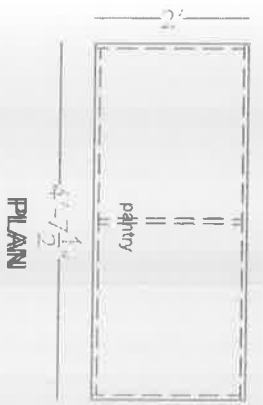
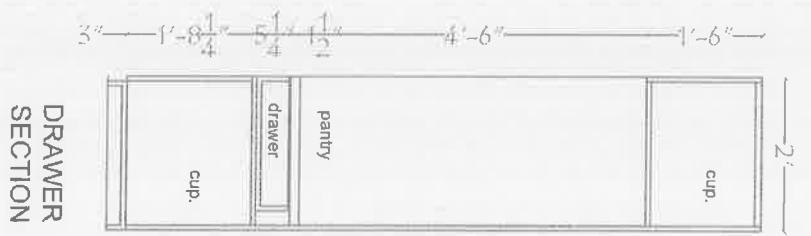
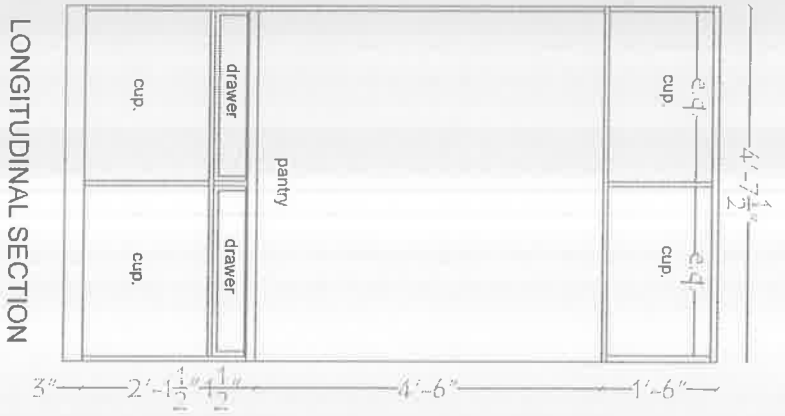
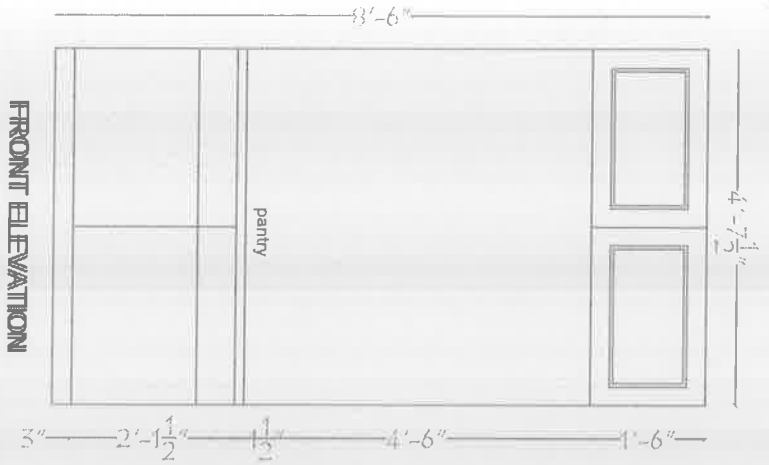

JOB TITAL-
PROPOSED INTERIOR WORK OF
BANK OF MAHARASHTRA
BRANCH - LIMB , DIST-SATARA
CLIENT - BANK OF MAHARASHTRA

PANTRI UNIT
DRAWING NO: 09
04-12-2020



08

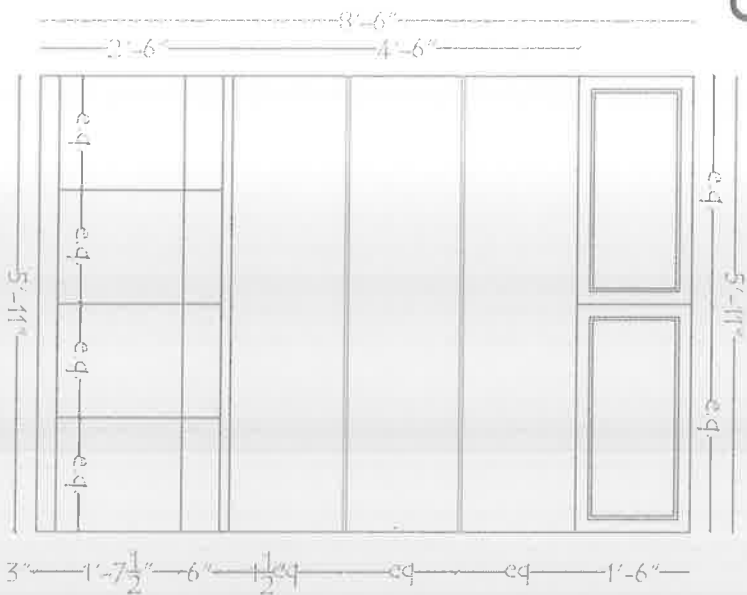

FRONT ELEVATION

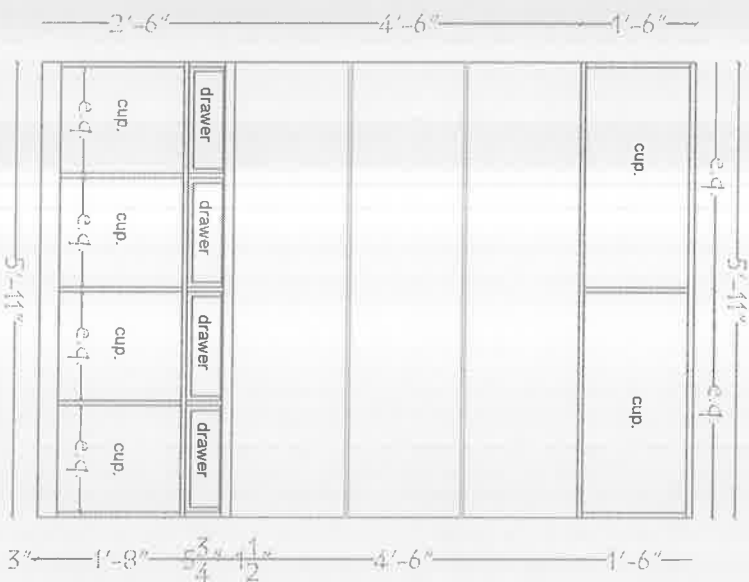

LONGITUDINAL SECTION

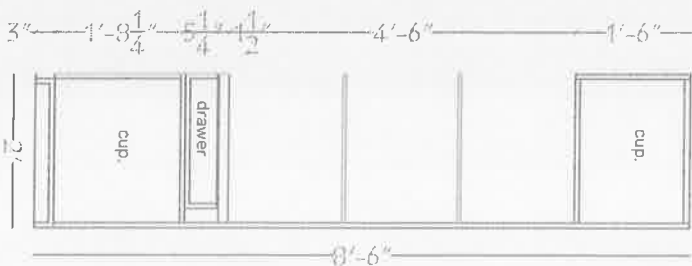

DRAWER SECTION

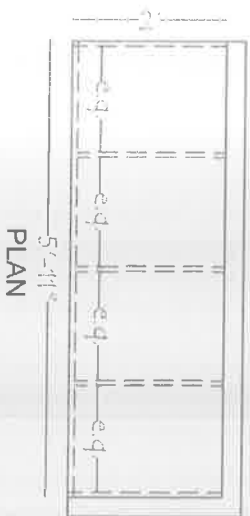

PLAN

JOB TITIAL-
PROPOSED INTERIOR WORK OF
BANK OF MAHARASHTRA
BRANCH - LIMB , DIST-SATARA
CLIENT - BANK OF MAHARASHTRA

STORAGE CUP. UNIT
DRAWING NO: 08
04-12-2020



STUDIO
GENESIS
ARCHITECTURE | INTERIOR | LANDSCAPE